

SHELTER ME

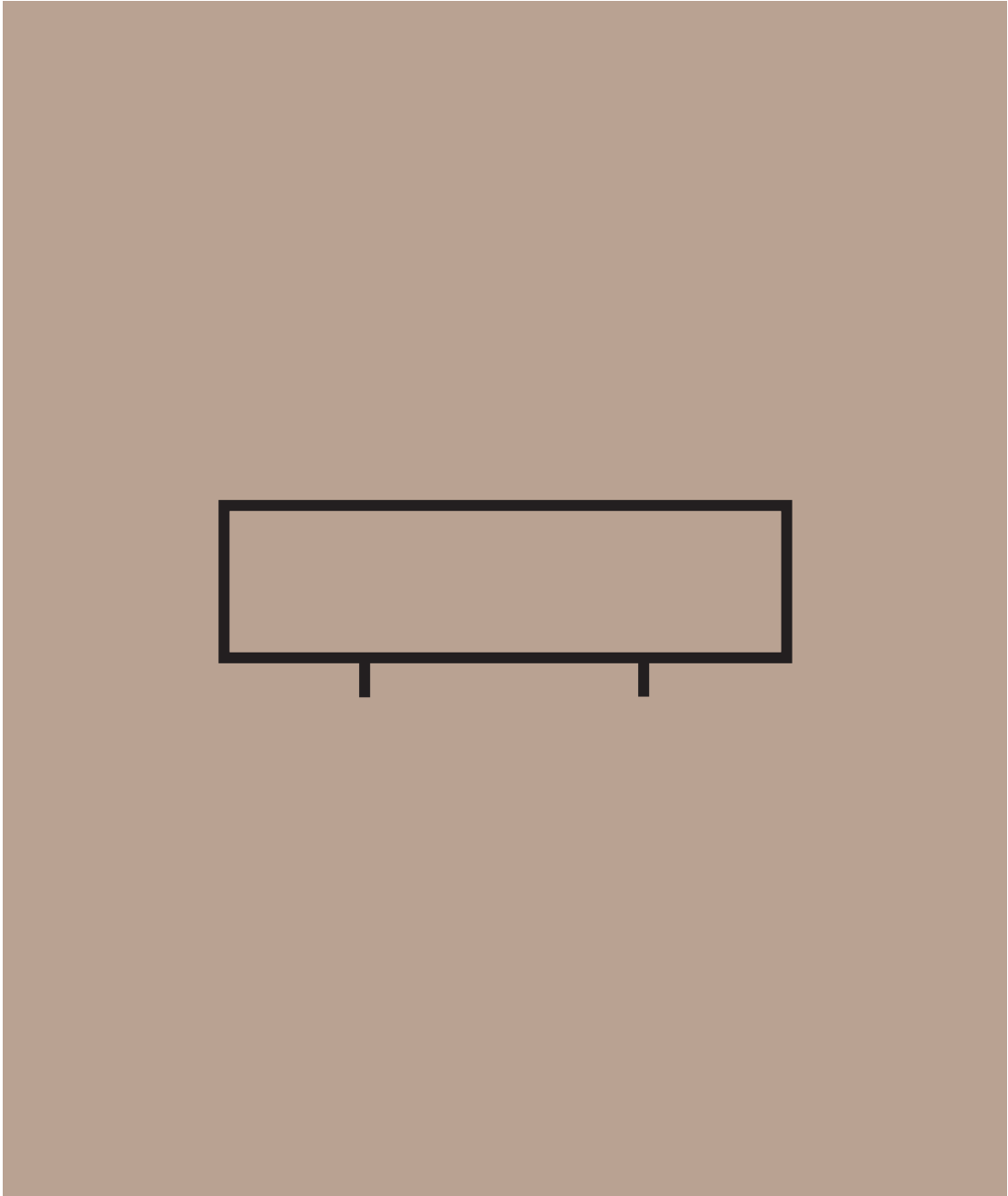

Acoustic Desk Screen



Product Sheet

AKUART

Shelter Me



PRODUCT DESCRIPTION

Shelter me is an efficient and beautiful shield from the hustle and bustle of everyday office life. As part of the AKUART acoustic screen family this desk screen shares the same acoustic characteristics and complete freedom to make your own designs as the rest of the AKUART collection. Shelter Me stands out by its adjustable clamp mounts and changeable printed front and backside canvases. It is available in 7 standard sizes but can also be ordered in custom sizes.

SPECIFICATIONS

Product:	Desk screen with a replaceable printed canvas (on both sides)
Acoustic material:	PET from 100% recycled plastic bottles
Core material:	Honeycomb structure vinyl
Corners:	Discrete ABS plastic corner inserts
Textile covers:	Printed polyester based fabric
Frame:	Matt fine structure powder coated aluminum
Mounts:	Adjustable matt fine structure powder coated steel clamps

SPECIAL FEATURES

Canvas: The stretched printed fabric can easily be removed and changed without having to disassemble or remove the frame from the wall. The fabric is form-stable and ensures that it does not wrinkle or fold when mounted on the frame. This applies throughout the product life cycle. The fabric is not sensitive to cold, heat or moisture. The canvas endures disinfection with anti bacterial and alcohol/chlorine based cleaning products without affecting the print. It also endures repeated machine wash.

Corner Inserts: Discrete ABS plastic inserts in the corners ensure that the aluminum frame profiles are assembled without exposed and sharp edges.



FRAME COLORS / FINISHES



White
RAL 9003



Black
RAL 9011



Charcoal
RAL 7021



Grey
RAL 7004

CUSTOM FRAME COLORS



Frames in custom RAL or NCS colors can be delivered with different structures. Price and finish on request.

DIMENSIONS

// LENGTH: 120 CM / 47,24"
 // DEPTH: 5 CM / 1,97"
 // HEIGHT: 65 CM / 25,59"

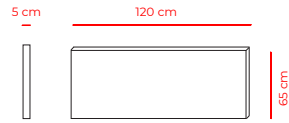

// LENGTH: 130 CM / 51,18"
 // DEPTH: 5 CM / 1,97"
 // HEIGHT: 65 CM / 25,59"

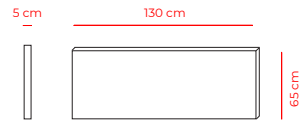

// LENGTH: 140 CM / 55,12"
 // DEPTH: 5 CM / 1,97"
 // HEIGHT: 65 CM / 25,59"

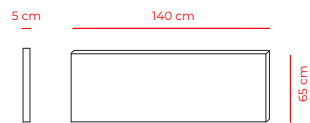

// LENGTH: 150 CM / 59,05"
 // DEPTH: 5 CM / 1,97"
 // HEIGHT: 65 CM / 25,59"

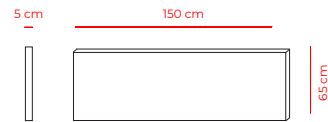

// LENGTH: 160 CM / 62,99"
 // DEPTH: 5 CM / 1,97"
 // HEIGHT: 65 CM / 25,59"

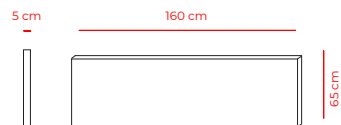

// LENGTH: 180 CM / 70,87"
 // DEPTH: 5 CM / 1,97"
 // HEIGHT: 65 CM / 25,59"

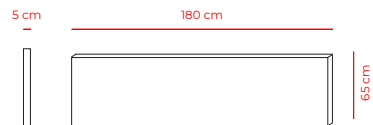

// LENGTH: 200 CM / 78,74"
 // WIDTH: 5 CM / 1,97"
 // HEIGHT: 65 CM / 25,59"

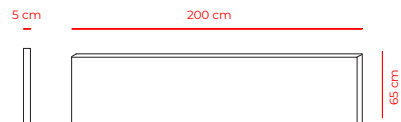

CUSTOM SIZES

The Shelter Me desk screen offers format flexibility.

Special sizes can be ordered in up to:

Length: Max. 270 cm / 106.29" x Height: Max. 100 cm / 39.37"

MOUNT

Shelter Me is attached to the desk top with clamp mounts. The mounts differ by having an additional adjustable function that ensures that The Desk Screen can be slightly tilted back and forth. This secures that the screen is always vertically levelled, despite of any irregularities in the floor surface. This feature also secures that several desk screens align perfectly when placed continuously besides each other.

// The Desk Screen is mounted 10 cm / 3,93" below the desk top

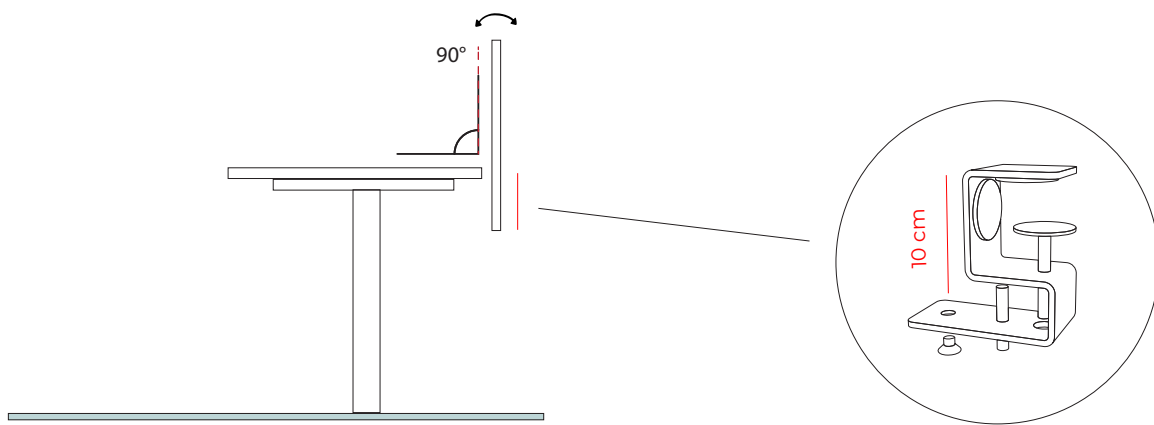

DESK TOP SPECIFICATIONS

// Max. table top height: 4 cm / 1.57 "
// Max. length of bevel table top edge: 3 cm / 1.18 "

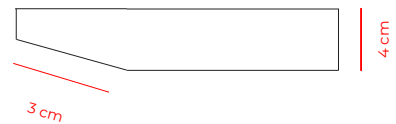

CANVAS

Function:	Replaceable/Detachable
Fire retardant:	Classification B-s1 according to DIN EN 13501-1.
Environment:	Tested free from harmful substances according to Eco-Tex 100

PRINT

Ink type:	Water-based ink
Printing method:	Dye sublimation print (fully embedded in canvas fabric)
Environment:	Tested free from harmful substances according to Eco-Tex 100

ACOUSTIC MATERIAL

Absorption:	Test results according to ISO 354. Classification according to ISO 11654
Flammability:	Classification A2-s1,d0 according to DIN EN 13501-1
Environment:	M1 Emission Classification of Building Materials, CE label, A+

PRODUCT CARE

Cleaning:	Shelter Me is easy to clean. It can withstand daily dusting, vacuuming and wiping with a semi wet cloth with the use of universal cleaning products.
Disinfectable:	The canvas is easy to disinfect. It endures the use of anti bacterial spray or anti bacterial wipes and alcohol chlorine based cleaning products without affecting the print.
Washable:	The canvas tolerates machine wash repeatedly.

ABSORPTION

The acoustic efficiency is tested by third party acoustic engineers in a sound engineering laboratory at the Technological University of Denmark. This means that architects, building consultants and designers can count 100% on the acoustic characteristics of the The Desk Screen.

SOUND ABSORPTION TEST

Measurements performed according to DS/EN ISO 354

Freq. [Hz]	Equiv. sound abs. - area [m ²]		
	1/3-oct.	1/1-oct.	Ref.-curve
125	0,37	0,37	
250	0,55	0,49	-
500	1,10	0,94	-
1000	1,72	1,55	-
2000	1,89	1,87	-
4000	1,86	1,82	-

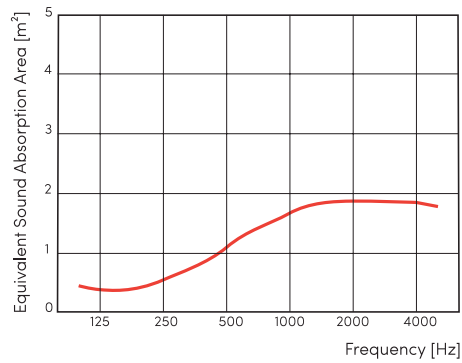

SOUND STOP TEST

New measurement method based on DS/ISO 10053

