

THE DESK SCREEN

Acoustic Screens by AKUART



Product Sheet // 2019-2020

The Desk Screen



PRODUCT DESCRIPTION

The Desk Screen is an effective and beautiful shield from the hustle and bustle of everyday office life. As part of the AKUART acoustic screen family the screen shares the same acoustic characteristics and complete freedom to make your own designs as the rest of the AKUART collection. It is as flexible as it is functional and stands out by its adjustable clamp mounts and replaceable printed front and backside textile covers. It is available in 7 standard sizes but can also be ordered on request in custom sizes.

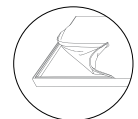
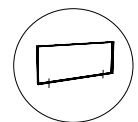

COMPONENTS

Product:	Desk screen with replaceable front and backside textile cover
Acoustic material:	PET from 100% recycled plastic bottles
Core material:	Honeycomb structure vinyl
Corners:	Powder coated ABS
Textile covers:	Printed woven polyester textile
Frame:	50 mm powder coated aluminum
Mounts:	Adjustable powder coated steel clamps

FRAME COLOUR / FINISH

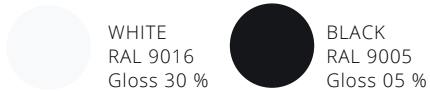

ACOUSTIC MATERIAL

Absorption:	Test results according to EN ISO 354
Flammability:	Fire retardent. Classification: B-s1,d0 according to EN ISO 11925-2 & EN 13823.
Sustainability:	Made from 100% recycled plastic bottles.
Environment:	Carbon foot print 4 times lower than usual PET fibres

CANVAS

Function:	Changeable/Detachable
Flammability:	Fire retardent. Classification B-s1 according to DIN EN 13501-1
Environment:	Tested free from harmful substances according to Eco-Tex 100
Maintenance:	Endures daily dusting, vacuum cleaning and weekly wiping with a wet cloth and can be machine washed on a gentle wash cycle at 40 degrees celcius.



DIMENSIONS

// LENGTH: 120 CM / 47,24"
// WIDTH: 5 CM / 1,97"
// HEIGHT: 65 CM / 25,59"

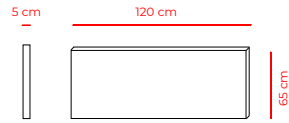

// LENGTH: 130 CM / 51,18"
// WIDTH: 5 CM / 1,97"
// HEIGHT: 65 CM / 25,59"

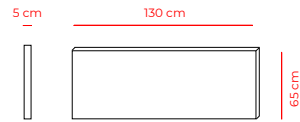

// LENGTH: 140 CM / 55,12"
// WIDTH: 5 CM / 1,97"
// HEIGHT: 65 CM / 25,59"

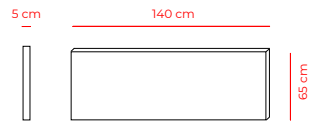

// LENGTH: 150 CM / 59,05"
// WIDTH: 5 CM / 1,97"
// HEIGHT: 65 CM / 25,59"

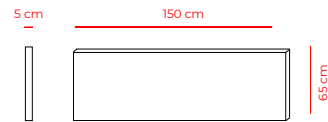

// LENGTH: 160 CM / 62,99"
// WIDTH: 5 CM / 1,97"
// HEIGHT: 65 CM / 25,59"

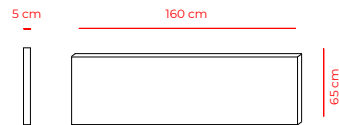

// LENGTH: 180 CM / 70,87"
// WIDTH: 5 CM / 1,97"
// HEIGHT: 65 CM / 25,59"

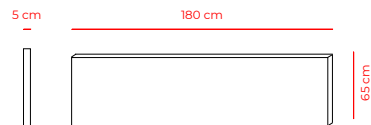

// LENGTH: 200 CM / 78,74"
// WIDTH: 5 CM / 1,97"
// HEIGHT: 65 CM / 25,59"

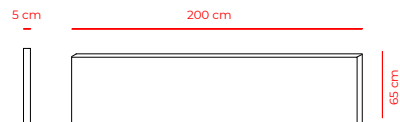

MOUNT

The Desk Screen is attached to the desk top with clamp mounts. The mounts differ by having an additional adjustable function that ensures that The Desk Screen can be slightly tilted back and forth. This secures that the screen is always vertically levelled, despite of any irregularities in the floor surface. This feature also secures that several desk screens align perfectly when placed continuously besides each other.

// The Desk Screen is mounted 10 cm / 3,93" below the desk top

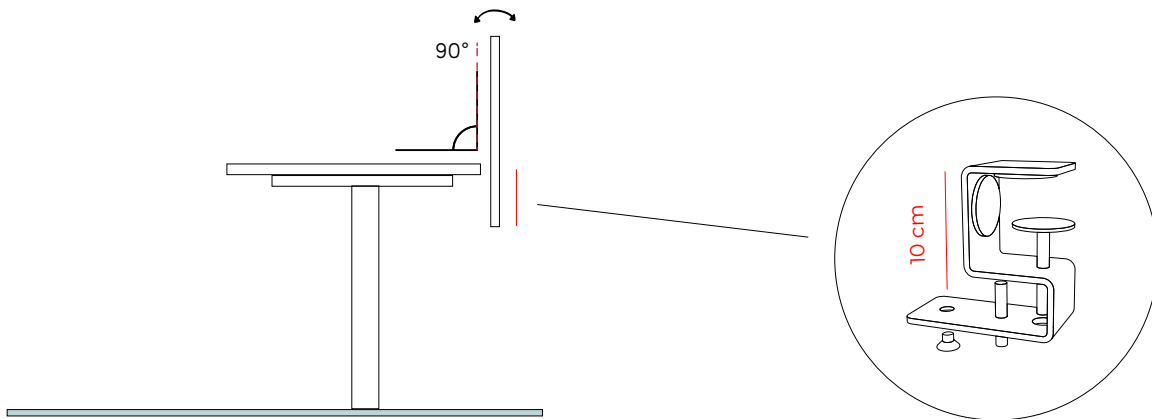

DESK TOP SPECIFICATIONS

// Max. table top height: 4 cm / 1.57 "

// Max. length of bevel table top edge: 3 cm / 1.18"

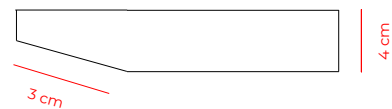

ABSORPTION

The acoustic efficiency is tested by third party acoustic engineers in a sound engineering laboratory at the Technological University of Denmark. This means that architects, building consultants and designers can count 100% on the acoustic characteristics of the The Desk Screen.

SOUND ABSORPTION TEST

Measurements performed according to DS/EN ISO 354

Freq. [Hz]	Equiv. sound abs. - area [m ²]		
	1/3-oct.	1/1-oct.	Ref.-curve
125	0,37	0,37	
250	0,55	0,49	-
500	1,10	0,94	-
1000	1,72	1,55	-
2000	1,89	1,87	-
4000	1,86	1,82	-

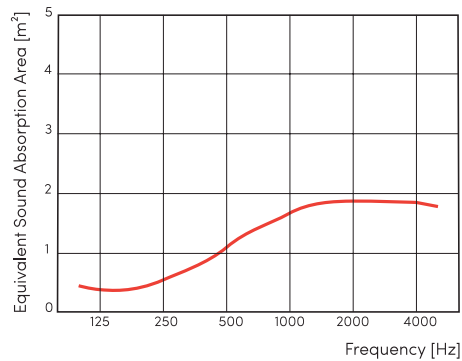

SOUND STOP TEST

New measurement method based on DS/ISO 10053

