

INSTALLATION MANUAL

**SMARTART 60
OVERSIZE**

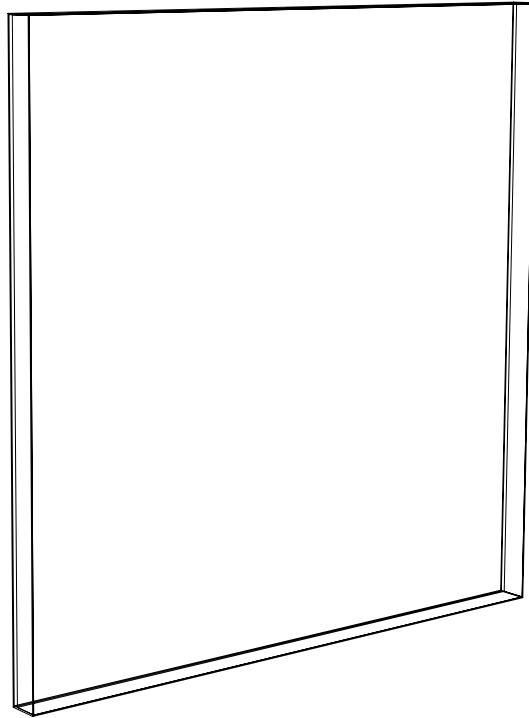

Installation Manual Video:
<https://player.vimeo.com/video/301830991>

COMPONENTS

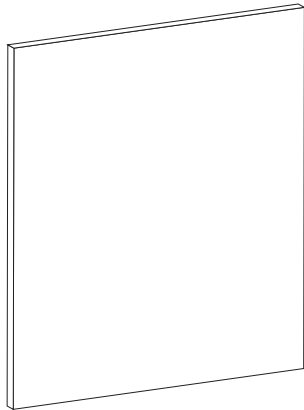

ACOUSTIC PLATES

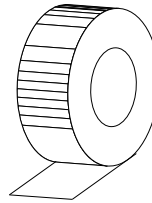

x 1

TAPE

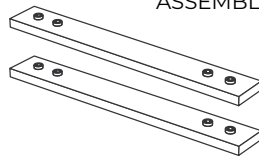

FRAME PROFILE
ASSEMBLY FITTINGS

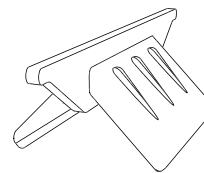

x 4

FRAME PROFILE
CONNECTORS

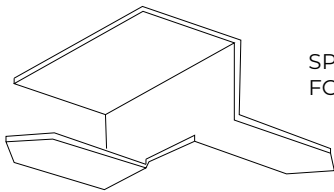

SPEAR BRACKETS
FOR ACOUSTIC PLATES

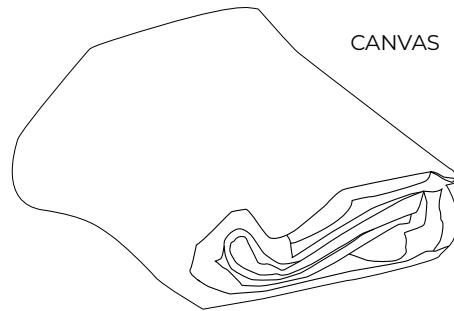

CANVAS

TOOLS

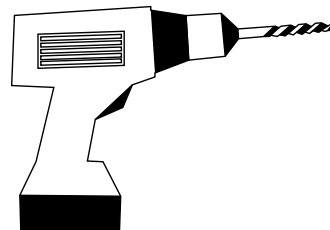
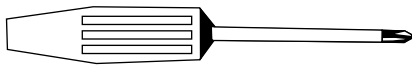

If necessary use spacers if
the wall surface is not level

1

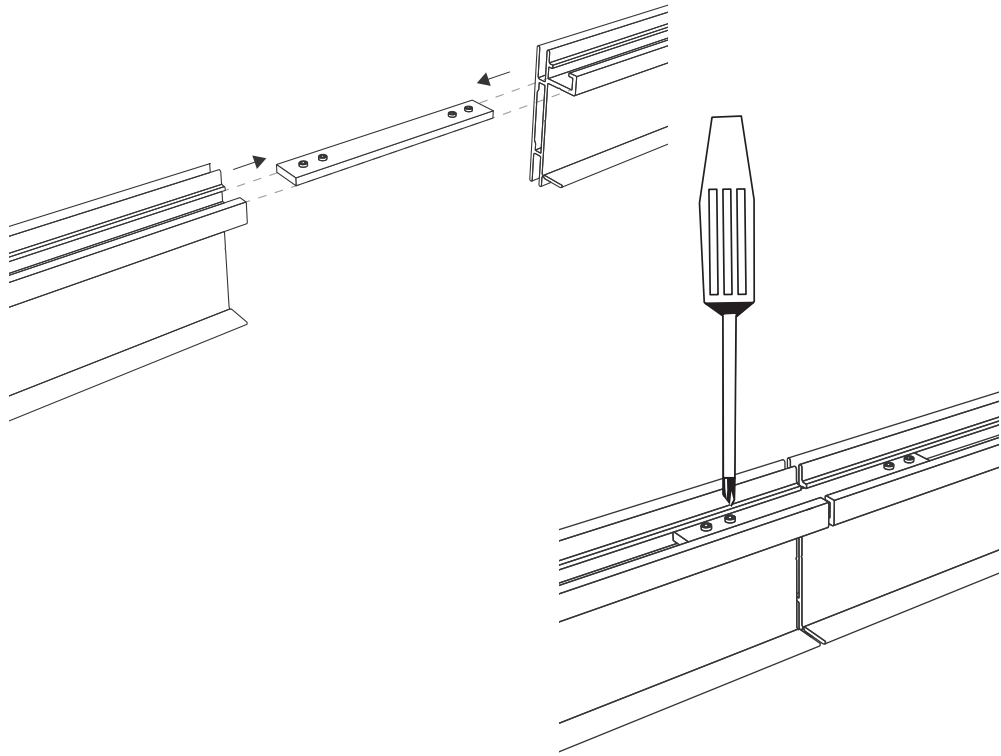

2

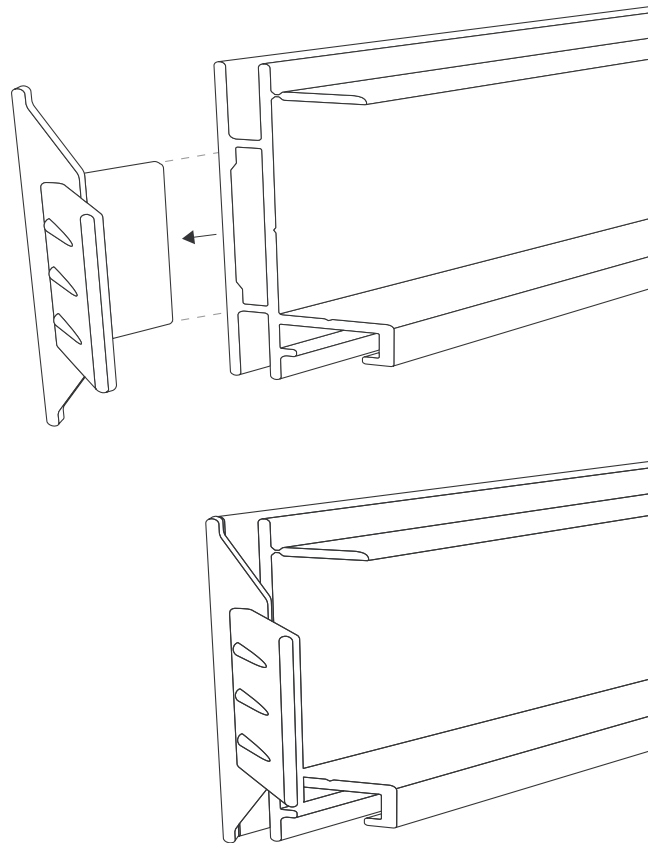

3

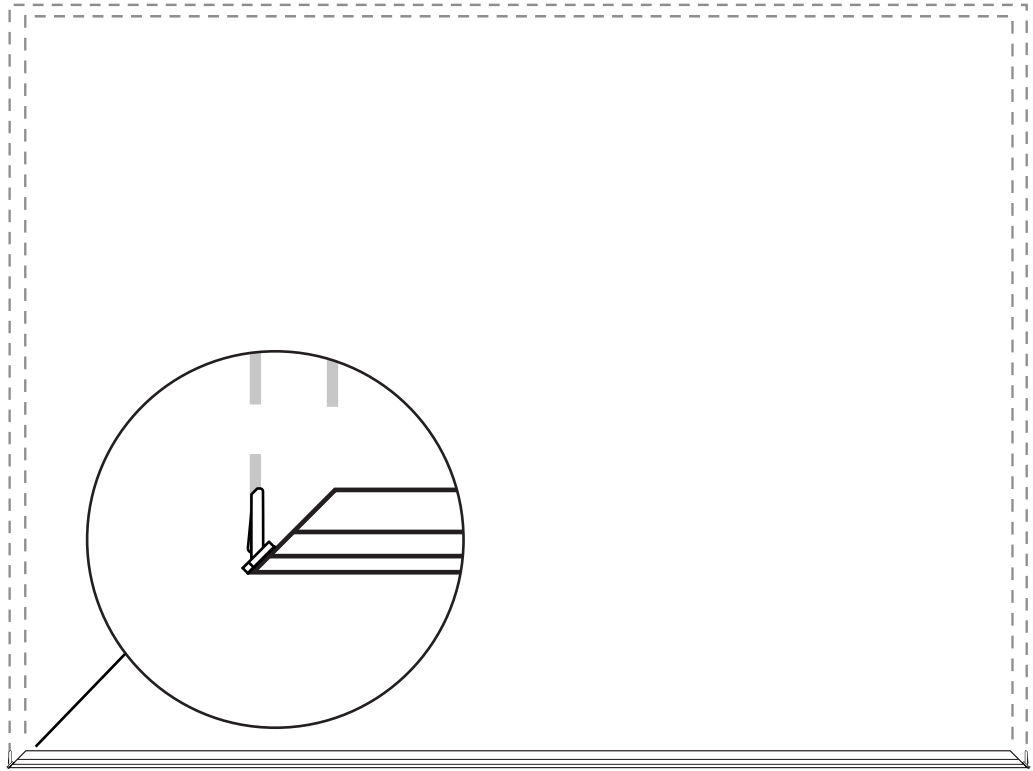

4

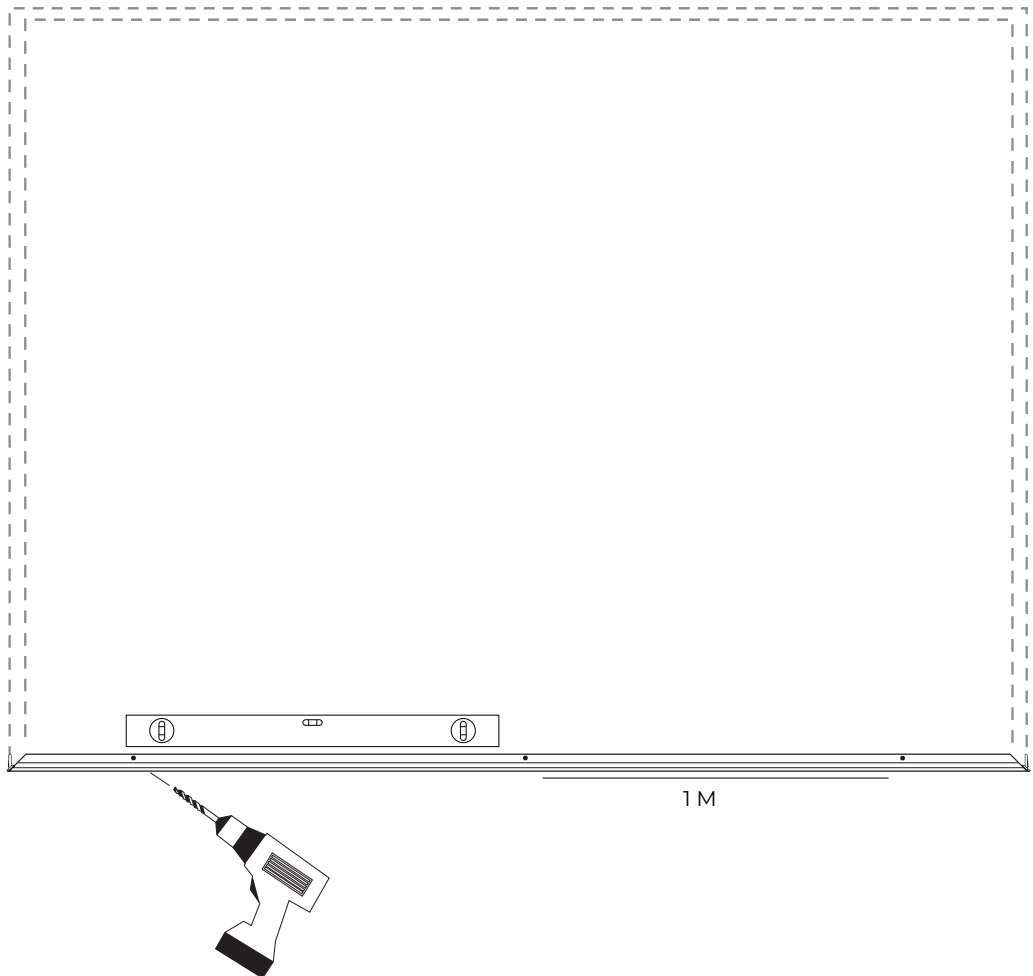

5

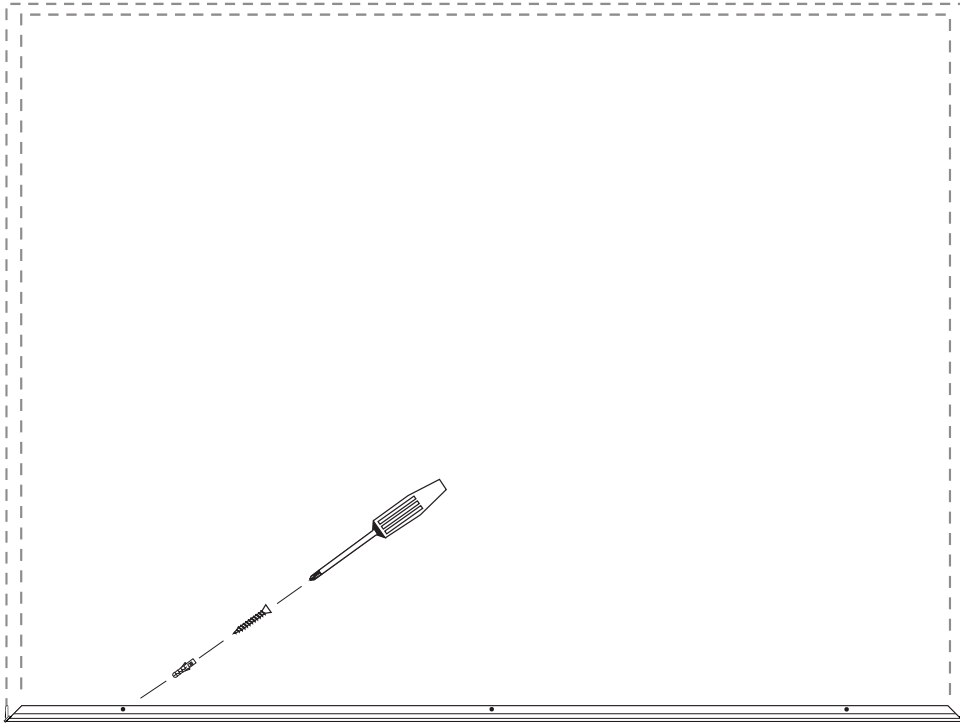

6

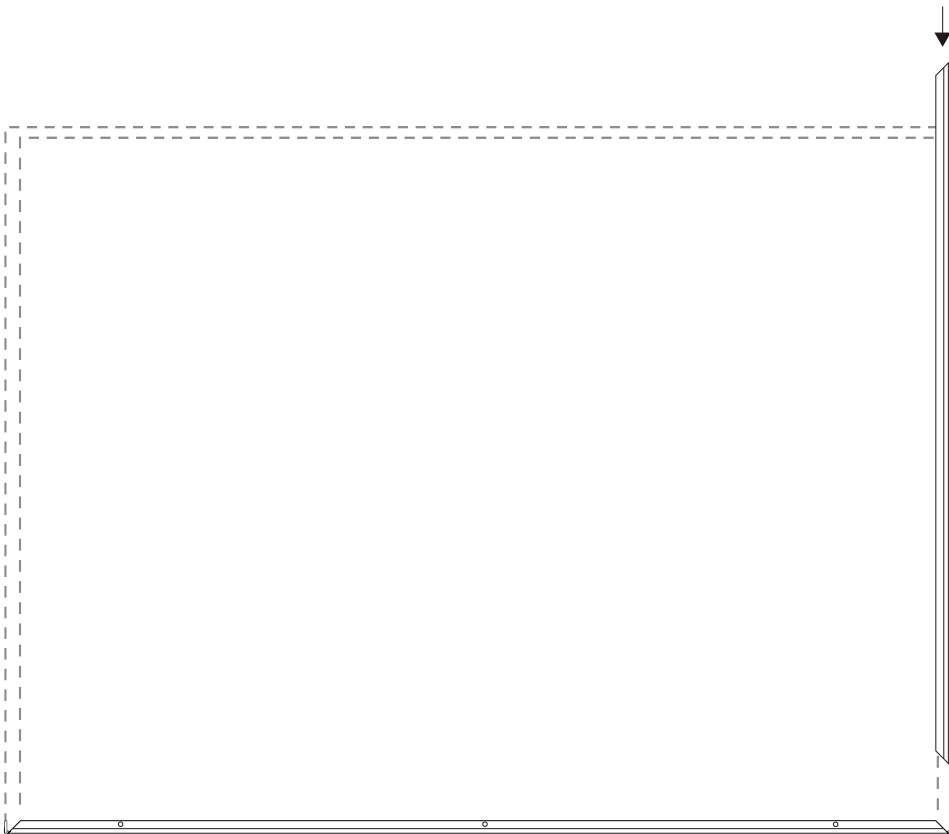

7

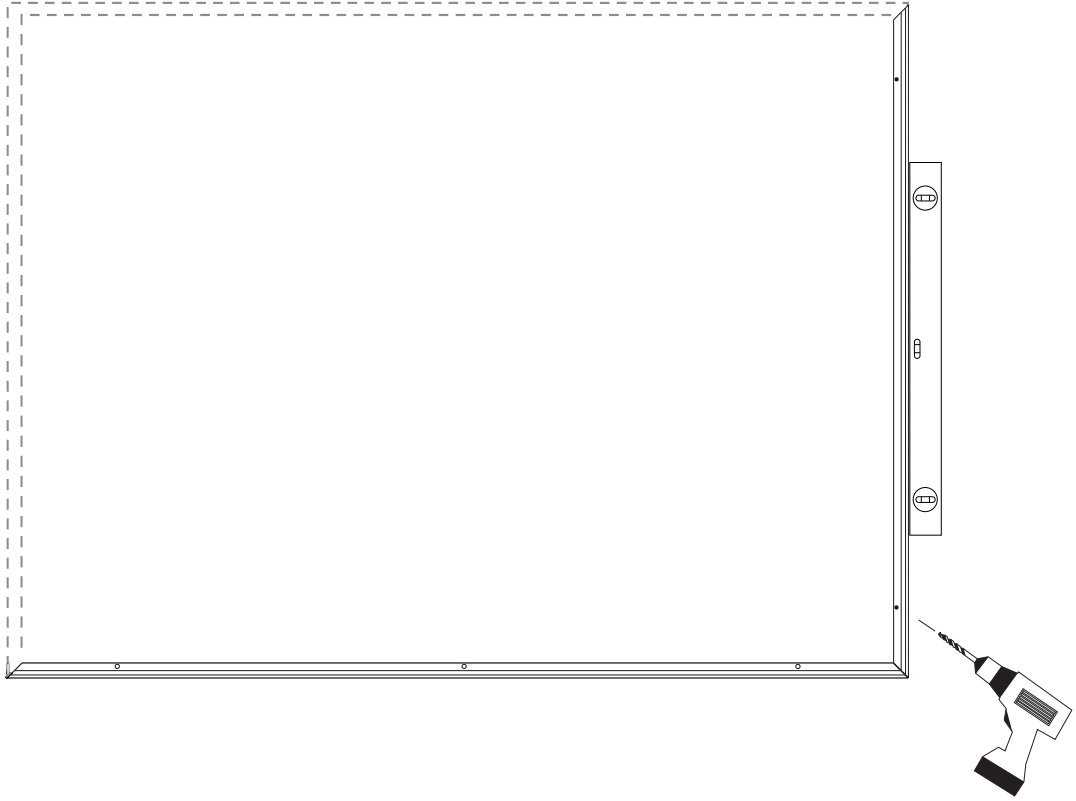

8

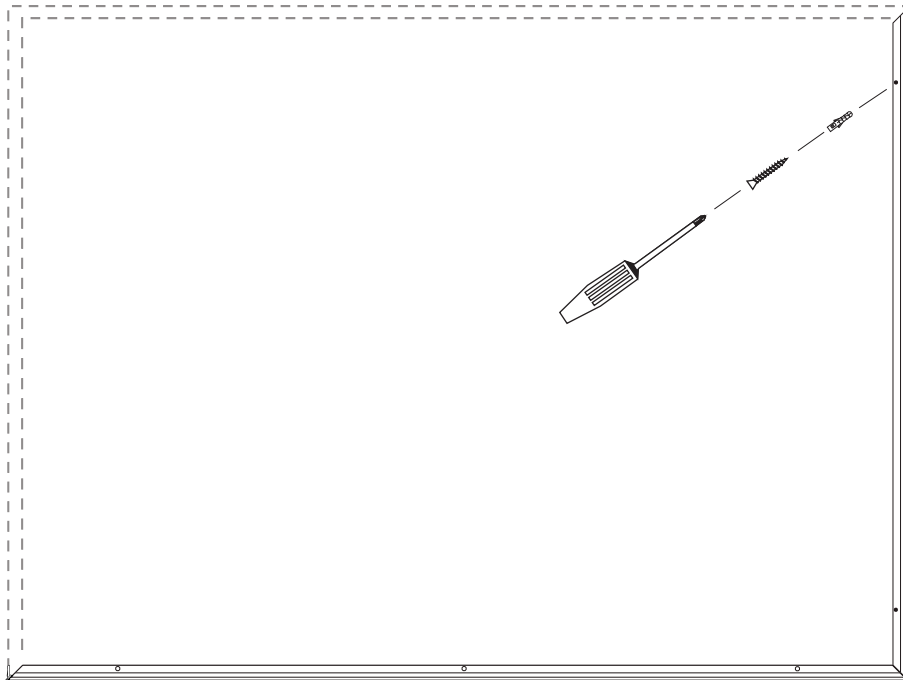

9



10

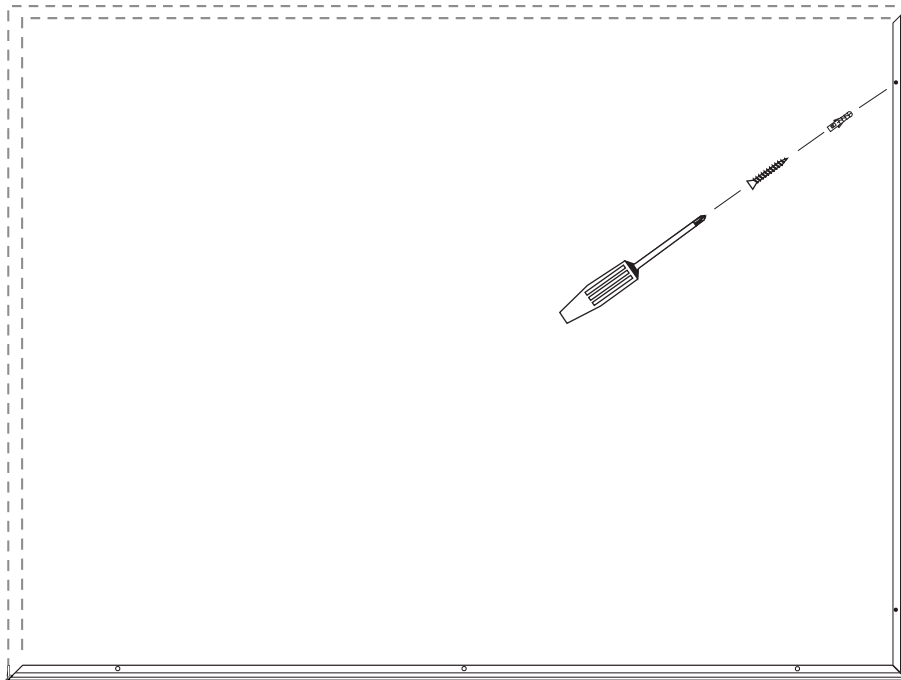

11



12

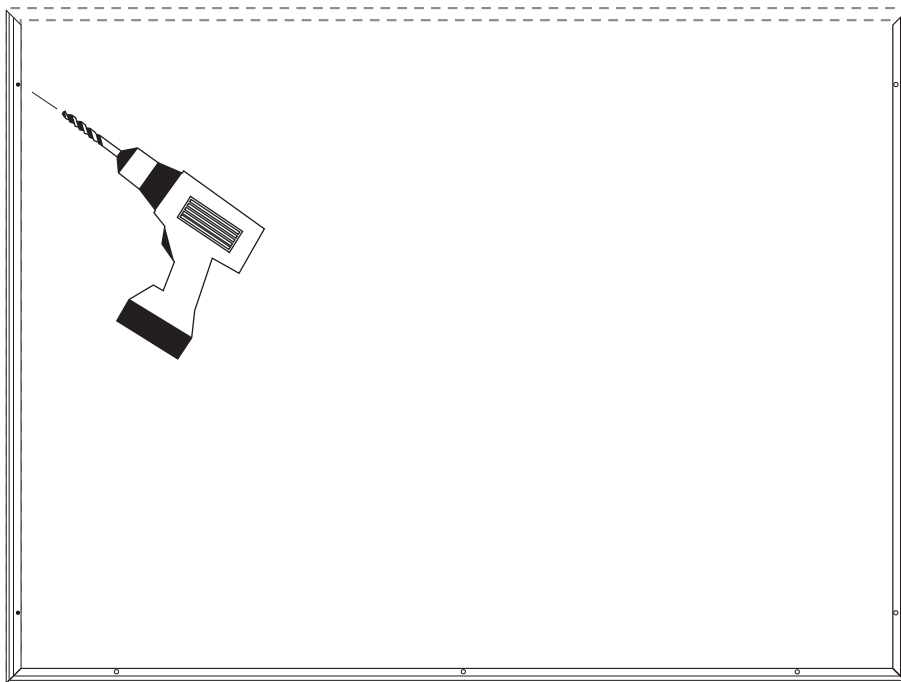

13

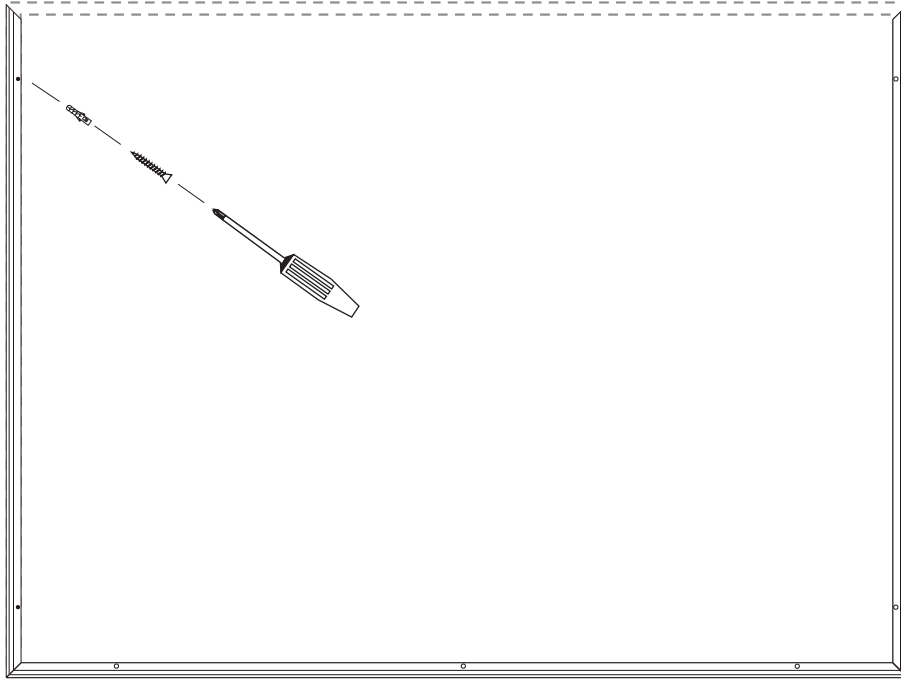

14

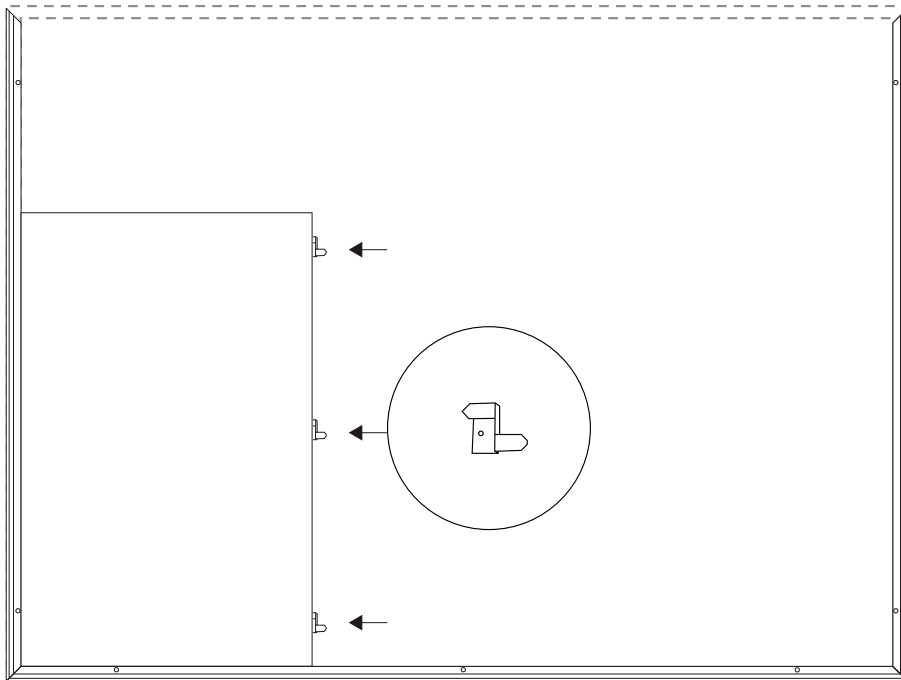

15

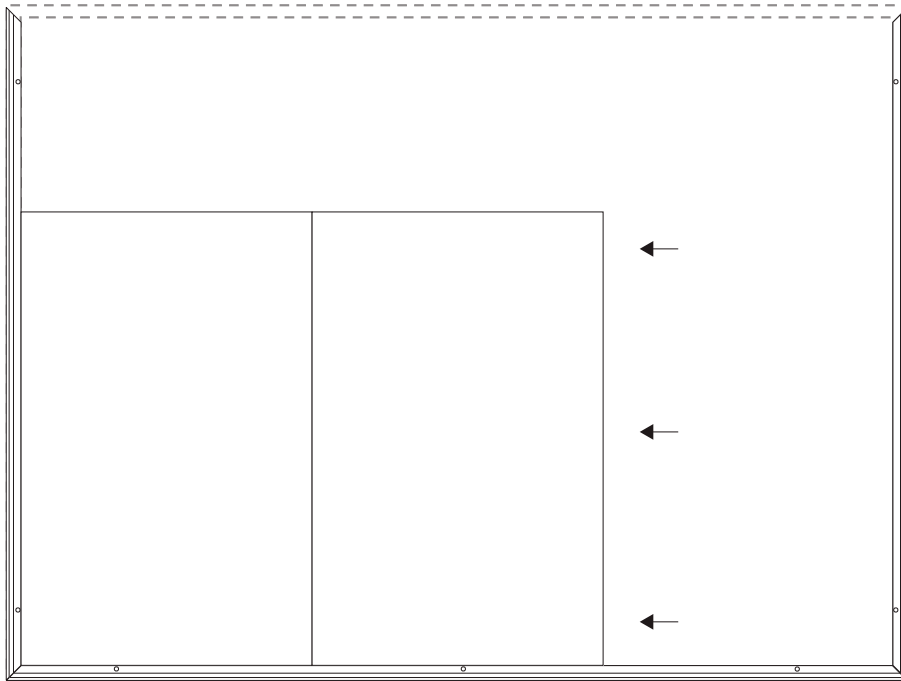

16

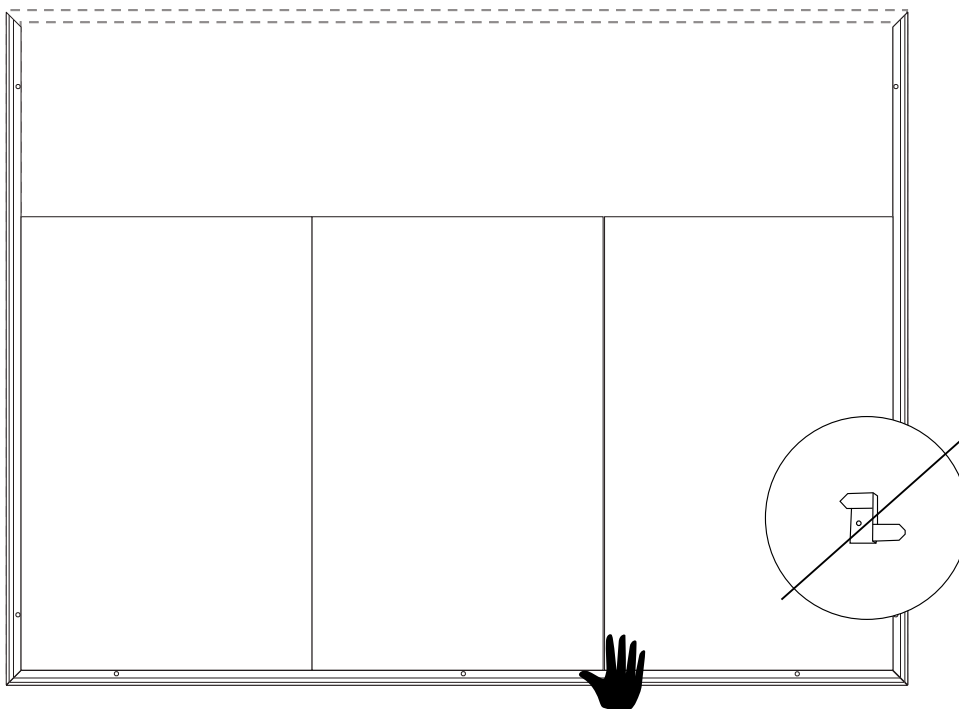

17

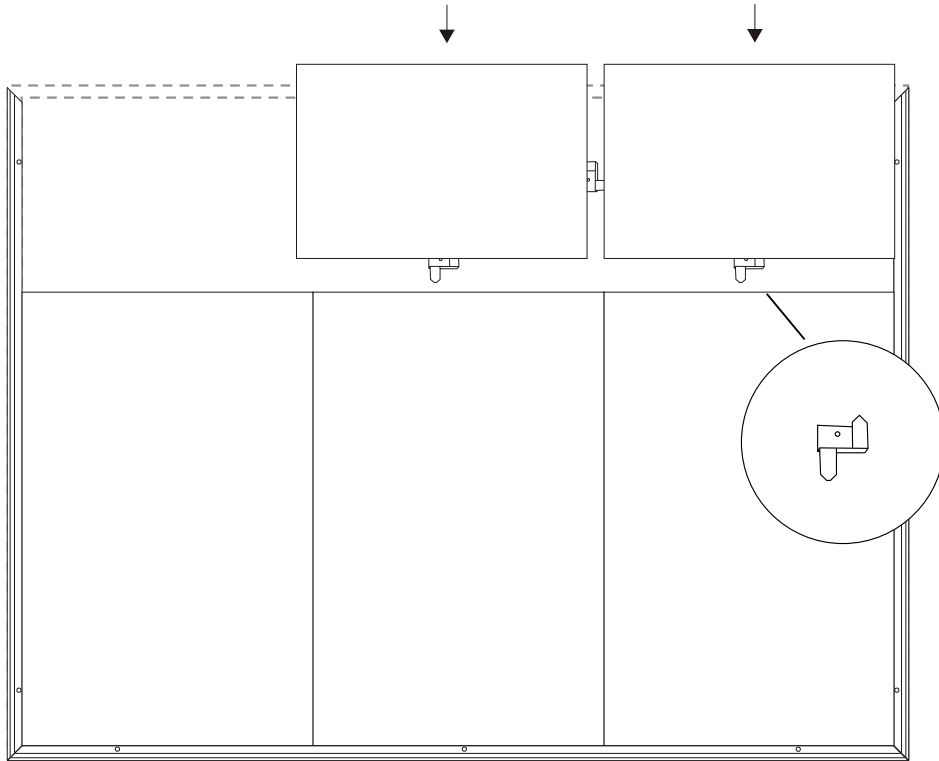

18

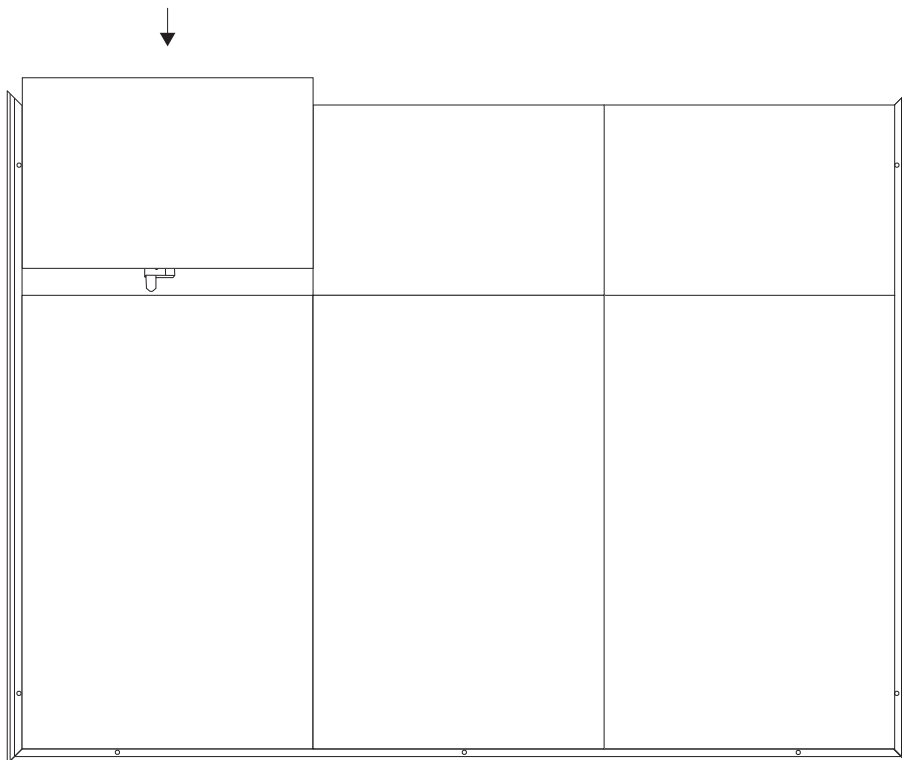

19

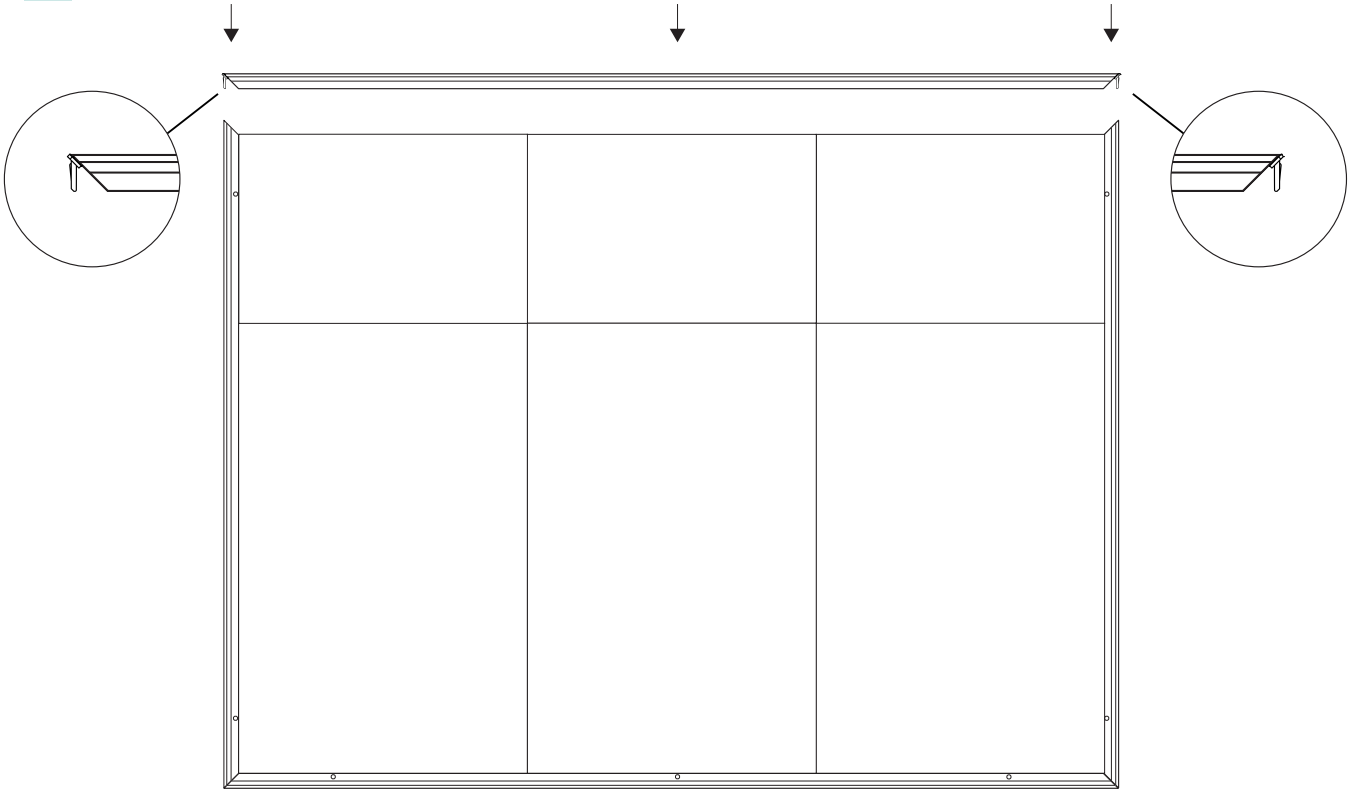

20

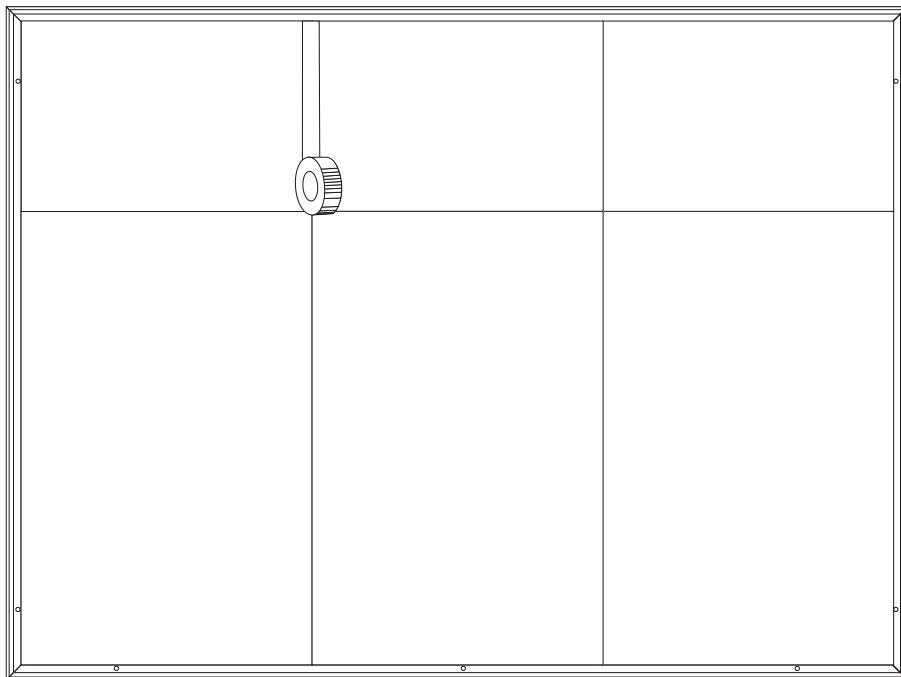

21

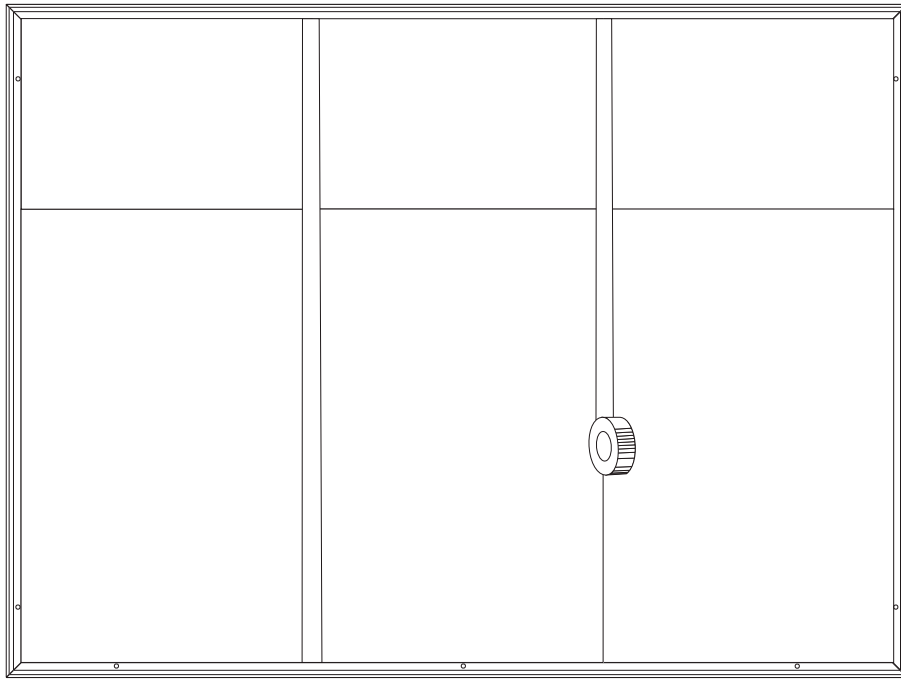

22

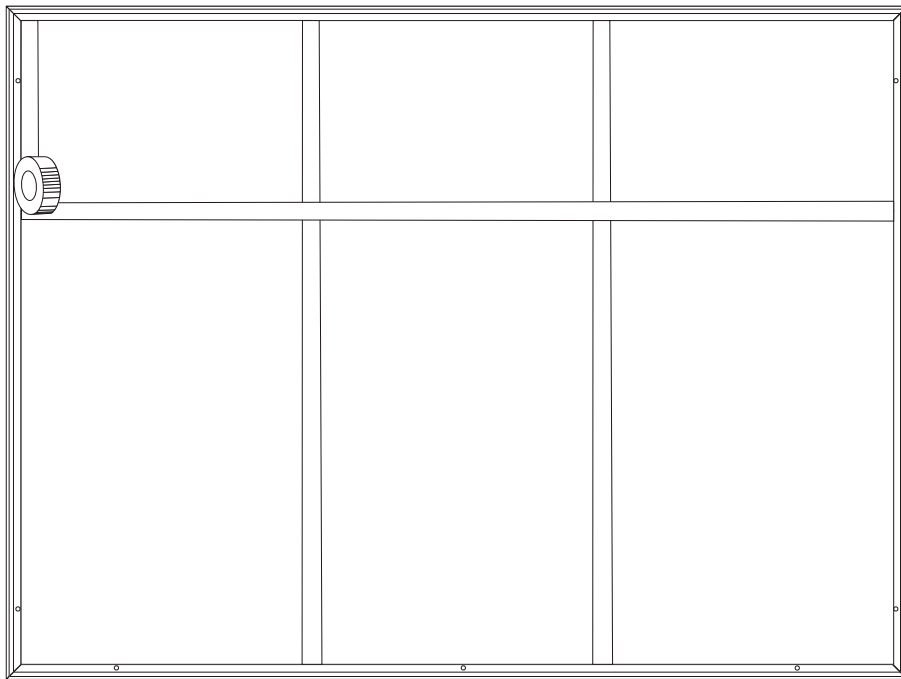

NOTE: When installing black frames, tape all the way around the inner edge to avoid the black aluminum snippet to be visible through the canvas.

23

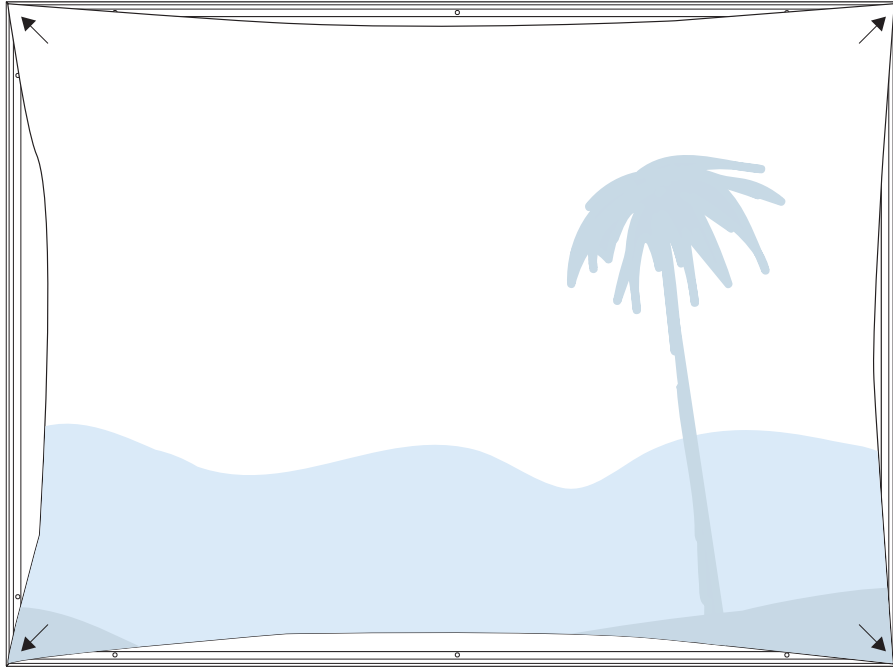

24

